

NATIONAL AERONAUTICS AND SPACE ADMINISTRATION

Technical Memorandum 33-741

*Evaluation of a Microwave High-Power
Reception-Conversion Array for
Wireless Power Transmission*

R. M. Dickinson

(NASA-CR-145425) EVALUATION OF A MICROWAVE
HIGH-POWER RECEPTION-CONVERSION ARRAY FOR
WIRELESS POWER TRANSMISSION (Jet Propulsion
Lab.) 25 p. HC \$3.50 CSCL 22E

N76-11207

Unclass

93/15 03093

**JET PROPULSION LABORATORY
CALIFORNIA INSTITUTE OF TECHNOLOGY
PASADENA, CALIFORNIA**

September 1, 1975



TECHNICAL REPORT STANDARD TITLE PAGE

1. Report No. 33-741	2. Government Accession No.	3. Recipient's Catalog No.	
4. Title and Subtitle EVALUATION OF A MICROWAVE HIGH-POWER RECEPTION- CONVERSION ARRAY FOR WIRELESS POWER TRANSMISSION		5. Report Date September 1, 1975	
		6. Performing Organization Code	
7. Author(s) R. M. Dickinson		8. Performing Organization Report No.	
9. Performing Organization Name and Address JET PROPULSION LABORATORY California Institute of Technology 4800 Oak Grove Drive Pasadena, California 91103		10. Work Unit No.	
		11. Contract or Grant No. NAS 7-100	
		13. Type of Report and Period Covered Technical Memorandum	
12. Sponsoring Agency Name and Address NATIONAL AERONAUTICS AND SPACE ADMINISTRATION Washington, D.C. 20546		14. Sponsoring Agency Code	
15. Supplementary Notes			
16. Abstract Initial performance tests of a 24-m ² area array of rectenna elements are presented. The array is used as the receiving portion of a wireless-microwave power transmission engineering verification test system. The transmitting antenna was located at a range of 1.54 km. Output DC voltage and power, input RF power, efficiency, and operating temperatures were obtained for a variety of DC load and RF incident power levels at 2388 MHz. Incident peak RF intensities of up to 170 mW/cm ² have yielded up to 30.4 kW of DC output power. The highest derived collection-conversion efficiency of the array was greater than 80%.			
17. Key Words (Selected by Author(s)) Microwave Power Transmission		18. Distribution Statement Unclassified -- Unlimited	
19. Security Classif. (of this report) Unclassified	20. Security Classif. (of this page) Unclassified	21. No. of Pages 24	22. Price

HOW TO FILL OUT THE TECHNICAL REPORT STANDARD TITLE PAGE

Make items 1, 4, 5, 9, 12, and 13 agree with the corresponding information on the report cover. Use all capital letters for title (item 4). Leave items 2, 6, and 14 blank. Complete the remaining items as follows:

3. Recipient's Catalog No. Reserved for use by report recipients.
7. Author(s). Include corresponding information from the report cover. In addition, list the affiliation of an author if it differs from that of the performing organization.
8. Performing Organization Report No. Insert if performing organization wishes to assign this number.
10. Work Unit No. Use the agency-wide code (for example, 923-50-10-06-72), which uniquely identifies the work unit under which the work was authorized. Non-NASA performing organizations will leave this blank.
11. Insert the number of the contract or grant under which the report was prepared.
15. Supplementary Notes. Enter information not included elsewhere but useful, such as: Prepared in cooperation with... Translation of (or by)... Presented at conference of... To be published in...
16. Abstract. Include a brief (not to exceed 200 words) factual summary of the most significant information contained in the report. If possible, the abstract of a classified report should be unclassified. If the report contains a significant bibliography or literature survey, mention it here.
17. Key Words. Insert terms or short phrases selected by the author that identify the principal subjects covered in the report, and that are sufficiently specific and precise to be used for cataloging.
18. Distribution Statement. Enter one of the authorized statements used to denote releasability to the public or a limitation on dissemination for reasons other than security of defense information. Authorized statements are "Unclassified-Unlimited," "U. S. Government and Contractors only," "U. S. Government Agencies only," and "NASA and NASA Contractors only."
19. Security Classification (of report). NOTE: Reports carrying a security classification will require additional markings giving security and downgrading information as specified by the Security Requirements Checklist and the DoD Industrial Security Manual (DoD 5220.22-M).
20. Security Classification (of this page). NOTE: Because this page may be used in preparing announcements, bibliographies, and data banks, it should be unclassified if possible. If a classification is required, indicate separately the classification of the title and the abstract by following these items with either "(U)" for unclassified, or "(C)" or "(S)" as applicable for classified items.
21. No. of Pages. Insert the number of pages.
22. Price. Insert the price set by the Clearinghouse for Federal Scientific and Technical Information or the Government Printing Office, if known.

PREFACE

The work described herein is the result of an investigation into the receiving aspects of the technological problems in microwave power transmission. The effort was prompted by the recent upsurge in interest in orbiting satellite power systems for importing power to earth. The work was performed by the California Institute of Technology's Jet Propulsion Laboratory for Sam Fordyce of NASA Headquarters Office of Applications and Simon Manson of NASA Headquarters Office of Energy Programs.

The technical efforts of JPL were under the cognizance of the Telecommunications Division.

ACKNOWLEDGMENT

Thanks are extended to Earl Jackson, Station Director of the Venus site at Goldstone, and all of the JPL and Aeronutronic-Ford personnel who assisted in the testing, and to Owen Maynard, Raytheon Co. Project Manager, and all of the Raytheon Co. personnel who contributed to the design, manufacture, installation and testing of the array. Particular thanks go to Bill Brown and Dave Salmond of Raytheon who respectively developed the rectenna and performed the field engineering.

CONTENTS

I.	Introduction	1
II.	The Concept	1
III.	Operating Principles	2
IV.	Rectenna Elements	3
V.	The Subarray	4
VI.	The Array	6
VII.	DC Load and Instrumentation	6
VIII.	The RXCV System Performance	8
IX.	Conclusions and Recommendations	9

TABLE

1.	Subarray performance, 17 subarrays at 130 mW/cm^2 calibration	12
----	---	----

FIGURES

1.	The Venus station 26-m antenna and collimation tower.	13
2.	Rectenna elements	14
3.	Rectenna element equivalent circuit	14
4.	Subarray wiring diagram	15
5.	The microwave power reception-conversion array (RXCV)	16
6.	Instrumentation and load system block diagram	17
7.	Lamp load in operation	17
8.	RXCV array and field strength calibration horn	18
9.	RXCV data receiving and recording equipment	19
10.	26-m antenna near field elevation pattern	20
11.	26-m antenna near field azimuth pattern	20
12.	1-dB incident beam contours	21

13.	Microwave high-power reception-conversion array performance	21
14.	Subarray power balance diagram for 162 mW/cm^2 peak RF incident flux density	22
15.	Subarray output voltage and load characteristics	22
16.	Subarray performance variation versus temperature	23
17.	Collection conversion efficiency versus load resistance for 130 mW/cm^2 peak incident RF power	23
18.	Monopulse pointing performance, microwave power transmission reception-conversion array	24
19.	Short circuit load performance of a subarray	24

ABSTRACT

Initial performance tests of a 24-m^2 area array of rectenna elements are presented. The array is used as the receiving portion of a wireless-microwave power transmission engineering verification test system.

The transmitting antenna was located at a range of 1.54 km. Output DC voltage and power, input RF power, efficiency, and operating temperatures were obtained for a variety of DC load and RF incident power levels at 2388 MHz. Incident peak RF intensities of up to 170 mW/cm^2 have yielded up to 30.4 kW of DC output power. The highest derived collection-conversion efficiency of the array was greater than 80%.

I. INTRODUCTION

The transmission of power without wires is far from a new concept. The sun and earth perform transmission and reception daily with randomly polarized, broadband emissions. Also, low-frequency coherent RF power radiation experiments of an omnidirectional nature were performed by Nikola Tesla (Refs. 1 and 2) at the turn of the century in Colorado.

Recently, Dickinson and Brown (Ref. 3) measured the overall end-to-end efficiency of a laboratory version of a directive microwave power transmission system at 54% for approximately 0.5 kW over a radiated distance of 1.7 m.

The current series of experiments to be described was specifically focused on only the high-power performance of a reception-conversion array (RXCV) rather than an overall system. Therefore, existing transmitting equipment was used, consisting of a klystron capable of up to 450 kW RF at 2.388 GHz, a 26-m (85-ft) diameter parabolic reflector antenna, and a 30.5-m (100-ft) tall collimation tower located approximately 1.54 km (1 mile) from the antenna (Fig. 1). The equipment is part of the Venus Station a research and development facility of the Deep Space Network, a facility of the National Aeronautics and Space Administration's Office of Tracking and Data Administration. The Venus Station is located at Goldstone in the Mojave Desert near Barstow, California.

The concept of microwave power transmission, the principles that are employed, the power collecting and rectifying elements, and the subarray and array organization will be described to prepare the reader for the system performance to be presented.

II. THE CONCEPT

The concept of transmitting significant quantities of power via microwaves does not differ greatly from the ordinary concept of communications via microwaves except that elements of the system are designed such that a major fraction of the transmitted beam is intercepted by the receiving part of the system.

Thus, the received power is a significant portion of the transmitter output rather than being typically on the order of hundreds of decibels down from the transmitter output. Otherwise, components and techniques familiar to most microwave engineers are used in the microwave power transmission system.

Even in the receiving end of the system to be described, the receiving process is still accomplished with a non-linear semiconductor diode detector device. However, the diode operates at a power level around +39 dBm instead of, for example, -50 dBm, and the baseband output is DC.

Although other power output forms such as pulsating DC or even low-frequency AC such as 60 Hz are possible to obtain, DC was selected for system simplicity at this time.

III. OPERATING PRINCIPLES

The power receiving system function is to collect the incident RF and to convert it to DC output as efficiently as possible. This function is performed in this case by having the RXCV in the form of a planar array of halfwave dipole antennas over a ground plane facing the transmitter incident beam. Each dipole has an integral low-pass filter, diode rectifier, and RF bypass capacitor.

The dipoles are DC insulated from the ground plane and appear as RF absorbers in parallel to the incoming RF wave. Their DC outputs are in a parallel and series combination to result in the desired output voltage and current levels.

The dipole length (0.47λ), the spacing of the dipoles one from the other (0.6λ) in a triangular lattice and from the ground planes (0.2λ) is adjusted such that when in combination with the transformed DC load impedance, the array provides a match for the incoming RF wave.

The low-pass filter design represents a compromise between insertion loss at the fundamental and proper rejection at the harmonics. The harmonics must be trapped and phased properly to result in maximum RF to DC conversion (inverse Fourier Transform).

The RF bypass capacitor performs the dual function of a smoothing filter for removing RF and harmonic ripple from the DC output, but more important, it performs as a part of a resonant RF impedance transformer to present the proper impedance match between the diode and the low-pass filter.

It should be stated here that even though the RF energy is collected with half-wave dipoles in a matched array, the RF energy is rectified by a half-wave rectifier, and the microwave system may transfer maximum power, the efficiency or ratio of DC output to RF input is by no means limited to $1/2 \times 1/2 \times 1/2 = 12.5\%$. Rather, 100% efficiency may be approached because the antenna elements and the radiation are coherent and orderly (not randomly) polarized, the diode rectifier circuit effective conduction cycle and reactive energy storage combine to yield up to 87% conversion efficiency maximum to date, and the generator equivalent resistance may approach zero for microwave power transmission systems.

IV. RECTENNA ELEMENTS

The dipole-diodes--RF collecting-converting elements or rectennas (Ref. 4)--are shown in Fig. 2 and the equivalent circuit in Fig. 3. The two halves of the balanced transmission line configuration are identical aluminum stampings. The inductors of the low-pass filter (LPF) are produced by decreasing the cross section of the line conductor.

At the LPF capacitor locations the transmission line halves are left large in area and are spaced close together and filled with a Teflon dielectric in order to yield the desired capacitance.

The ceramic-metal gold-plated package for the gallium-arsenide Schottky barrier diodes is conformally coated around the joints where it is attached to the aluminum transmission line halves.

The diode package anode is screwed into one side of the line for maximum thermal conductivity, whereas the package cap or cathode connection is press fitted against and conductively epoxied to the other transmission line half.

The RF bypass uses a 0.025-mm (1-mil) thick Kapton dielectric sandwiched between large area plates in order to produce the large value of capacitance required for yielding a good RF short circuit.

The transmission line halves extend to interface with the DC collection buss bar, which is an aluminum angle. The buss bar also acts as the predominant heat sink for the diode rectifiers. The diode junction temperature rise from the buss bar is calculated to be at most 35°C/W.

The balanced transmission line passage through the ground plane is contained within a round 0.2λ -long cylinder. The LPF capacitor dielectrics double as standoffs to center the element. The ground plane feedthrough cylinder acts as an RF choke to limit RF feedthrough the ground plane.

The air-spaced, high-Q balanced transmission line yields low loss under standard operating conditions. However, the open structure is subject to detuning by standing water drops until evaporated. The incident S-band RF energy speeds the evaporation process by stimulating rapid molecular vibrations as in microwave oven heating.

As part of the project quality control and in order to allow performance correlations, one wing of each dipole is progressively serialized by stamping in order to provide traceability for its diode, which exists all the way through the diode fabrication process back to its wafer quadrant position in the epitaxial growth reactor.

V. THE SUBARRAY

The previously described rectenna elements are combined into a subarray of 270 subelements arranged in an equilateral triangular grid formation. The subarray is 1.162 m (45.728 in.) wide \times 1.207 m (47.531 in.) high \times 0.127 m (5 in.) thick.

The subarray size was selected to allow the subarray to be readily handled manually. Each subarray weighs approximately 54 kg (120 lb). The ground plane perimeter is arranged on each subarray to allow correct juxtapositioning to provide unbroken ranks of dipoles in adjacent subarrays.

The subarray polarization is vertical linear in order to both (1) take less structure than circular polarization and (2) present a minimum attractive bird perch.

The DC wiring consists of 6 series groups of 3 each parallel-wired horizontal rows. Each row consists of 15 parallel diodes attached to one DC collection buss bar as shown in Fig. 4.

The quantity of 45 diodes in parallel in any one group was found to be sufficient to yield a combined short circuit current that is adequate for fusing open the 0.025-mm (1-mil) diameter gold wires used to bond from the diode chip to the diode package. This makes the subarray self clearing in case of a fault. Generally the most common diode failure mechanism is a punch through the epitaxial layer of the diode, which results in a shorted diode. The faults are generally the result of exceeding the reverse breakdown voltage due to excessive R.F. input and/or improper (light) DC loading conditions.

Another protective feature is an overvoltage crowbar unit on the output of the subarray. If the output voltage reaches a preset value, a short circuit is applied via an SCR. This reduces the voltage to protect the diodes in case of a light load condition, open circuit, or excessive RF input. The crowbar unit is self-resetting whenever the RF input is reduced and/or the load condition is corrected.

The subarray diodes are generally safe in a DC short condition because the resulting RF mismatch causes most of the incident RF power to be reflected. An open circuit load condition leads to a large fraction of reflected power also, but the open circuit yields high voltages at the diodes in contrast to the short circuit condition.

The subarrays incorporate mechanical provisions for varying simultaneously the spacing between the dipoles and the ground plane.

Performance status instrumentation is provided for RF input power and central buss bar temperature. The central dipole in the array is isolated from the DC power collection buss bar and is provided with its own output leads such that a separate load can be used to derive a sample of voltage proportional to the incident RF power. It also has its own crowbar unit.

The temperature data is obtained through use of a thermistor element attached to the central buss bar. The thermistor and its associated leads are RF bypassed and shielded in order to prevent RF heating of the element.

High-impedance bleeder resistors from the DC output leads are used to prevent charge buildup during subarray handling and storage. One side of the DC output is grounded to the subarray frame for lightning and personnel protection.

VI. THE ARRAY

The array is arranged in the format of three vertical columns by six horizontal rows. The array is filled with the exception of the top central subarray, which was deleted during the program in order to balance the project budget.

Figure 5 shows the array, which is mounted approximately half way up the face of the existing 30.5-m (100-ft) tall collimation tower on a hill which places the array 7 deg in elevation above the Venus Station 26-m (85 ft) diameter antenna. The antenna aperture to array spacing is 1.54 km.

The tower mounting was selected so as to yield reflection free illumination patterns and also for project safety in the event of unauthorized personnel wandering unannounced and uninvited in the high-power test range.

The array physical capture area, including the interstices between subarrays, is 24.5 m^2 (263.5 ft^2). Each of the 17 subarrays is positioned normal to the beam from the Venus station antenna. All subarrays lie in the same plane.

VII. DC LOAD AND INSTRUMENTATION

The 17 separate DC load and instrumentation wires from each subarray are routed to a central load and instrumentation complex located in and near the collimation tower support building.

Figure 6 shows the instrumentation and load system block diagram and indicates that the individual DC loads are each split such that approximately one third of the power is dissipated in a lamp load. The remainder is dissipated in power resistors. Precision calibrated current shunts and voltage dividers allow the DC power to be accurately calculated to within a measured accuracy of $\pm 1/2\%$.

The lamp loads shown in Fig. 7 are structured in the same geometrical arrangement as the power receiving array. The lamps are used to indicate visually how the RF energy density is varied across the array as the illuminating antenna is pointed over the array, yielding a one-to-one correspondence that is useful in convincing people that power is indeed being transmitted without wires.

A calibrated standard gain horn is fixed near the lower right side of the array (Fig. 8) to provide an accurately calibrated measure of the incident peak RF flux density. By the use of pre-programmed software and by directing the transmit antenna beam alternately at the calibration horn and the central isolated calibration element of each subarray, an accurate calibration of the incident RF power on each subarray is obtained. Long-term drifts or shifts in the diode calibration elements are thus minimized.

The calibration horn output power meter recorder output, the load current and voltage, and the temperature data are processed in an analog to digital converter for transmission via a 50-pair telephone data line to the Venus Station control room.

Figure 9 shows the data receiving and recording end of the system. A minicomputer is used to process the subarray output voltage, current, temperature and incident RF power data such as to provide engineering performance data and to provide threshold warning or automatic pre-set shutdown via klystron drive removal.

In addition to the data processing computer, a video quick-look data display unit and a combination cassette tape data recorder - hard copy printer are provided. Keyboard entry is used to command various data display formats and to set threshold warning levels or shutdown limits.

The data is formatted in the same 3×5 configuration as the subarrays and displays for each subarray the RF input power, the output DC power, the ratio or efficiency, the voltage and temperature of each subarray, and the total array input RF power, DC output, and average array efficiency.

A parallel, but isolated, switch selected digital voltmeter that is used to read the individual subarray voltages and an LED array brightness display are backup instrumentation in case of computer failure.

VIII. THE RXCV SYSTEM PERFORMANCE

The following data represents the collection of the RXCV operating performance to date. The incident illumination distribution is shown in the E and H-plane patterns (Figs. 10 and 11) of the 26-m antenna as measured with the standard gain horn at the array location before subarray installation. The power distribution was verified both via standard pattern cuts as well as by moving the standard gain horn over the proposed subarray locations when the transmitting antenna pointing position was held constant. Less than 0.1-dB pattern ripple was measured, indicating a clean, unobstructed illumination.

Because of the small size of the array relative to the 26-m-diameter antenna tubular beam, only about 11.3% of the klystron transmitter output is incident on the array (see Fig. 12) and is thus available for collection and conversion to DC output.

Figure 13 shows the DC power output and average collection-conversion efficiency of the array as a function of the incident peak RF flux density for the illuminating beam centered at the geometrical center of the array. The efficiency remains high over a large range of input power levels. As yet, the maximum efficiency operating point has not yet been reached. Figure 14 shows an estimated power balance diagram for a typical subarray.

Because of the partial lamp load, the total subarray load resistance varies with power level, as shown in Fig. 15. Also shown is the output voltage variation.

Figure 16 shows the results of an experiment to determine the array efficiency as a function of temperature. The thermal time constant of the subarray is approximately 16 minutes with an 8°C rise for operation at the design point. The low temperature rise reflects the high diode conversion efficiency and good heat sinking of the diodes.

Table 1 shows the statistical performance of the 17 subarrays for similar incident power conditions.

Figure 17 shows the subarray collection-conversion efficiency for various load conditions.

Figure 18 illustrates the usefulness of the modules of the array in determining the illumination beam peak pointing position. By subdividing the array as shown in the inset figures and performing the subarray output sum and difference power ratios relative to the respective reference lines, the resulting "monopulse" pointing data may be generated. Allowing for the variations in subarray off-axis biases and variations with power level, the beam center can be reliably located to within approximately 1/30 of a beam-width in the current case.

Figure 19 shows the short circuit load current performance of a subarray.

After accumulating approximately 65 total hours of operation at various power levels, the array was checked for failed diodes on Aug. 20, 1975. Out of the total of 4,590 diodes, only 18 diodes were faulted.

The failed diodes will be examined in an attempt to determine the cause of failure. However, it is known that the diodes were subjected to greater than normal design level RF intensity in the course of this initial checking of the system.

IX. CONCLUSIONS AND RECOMMENDATIONS

Over 30 kW of DC output power has been transmitted a distance of 1.54 km without wires. The ratio of total DC output to integrated total available incident RF power on the reception-conversion array was greater than 80%.

In order to improve the product, higher conversion efficiency diodes, better array impedance match, and mass-manufacturing simplicity of design for easier fabrication and assembly will be necessary.

Additional parameter variation tests are planned in the future to determine the performance versus frequency, incident polarization, treatment of the interstices, and various environmental conditions--including rain, snow, and angle of incidence variations.

In summary then, the present rectenna array concept should be adequate to provide a somewhat weather-dependent, yet highly efficient receiving mechanization for a high-power microwave power transmission link.

REFERENCES

1. O'Neill, J.J., Prodigal Genius, The Life of Nikola Tesla, Ives Washburn, Inc., N.Y., 1944
2. Hunt, I., and Draper, W., Lightning in His Hand, The Life Story of Nikola Tesla, Sage Books, Denver, 1964.
3. Dickinson, R., and Brown, W., Radiated Microwave Power Transmission System Efficiency Measurements, Technical Memorandum 33-727, Jet Propulsion Laboratory, Pasadena, Calif., May 15, 1975.
4. Brown, W., "The Technology and Application of Free-Space Power Transmission by Microwave Beam," in IEEE Proceedings, Vol. 62, No. 1, pp. 11-25, January 1974.

Table 1. Subarray performance, 17 subarrays at 130 mW/cm² calibration

Parameter	Average value	Range	Standard deviation
Input RF power, W	1888.6	30	9.5
Output DC power, W	1539.9	88	19.3
Collection-conversion efficiency, %	81.53	4	1.12
Output voltage, V	161.88	6	1.6
Load resistance, ohms	17.02	0.58	0.20

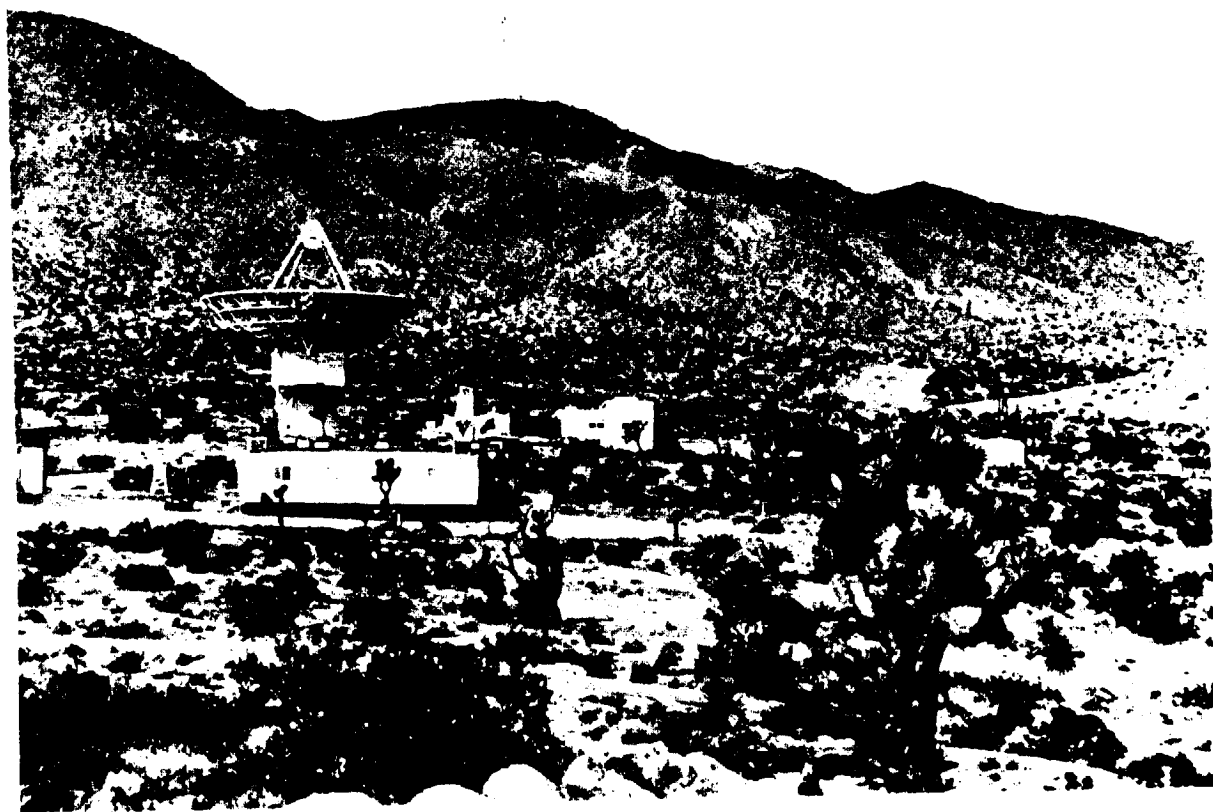

Fig. 1. The Venus station 26-m antenna and collimation tower

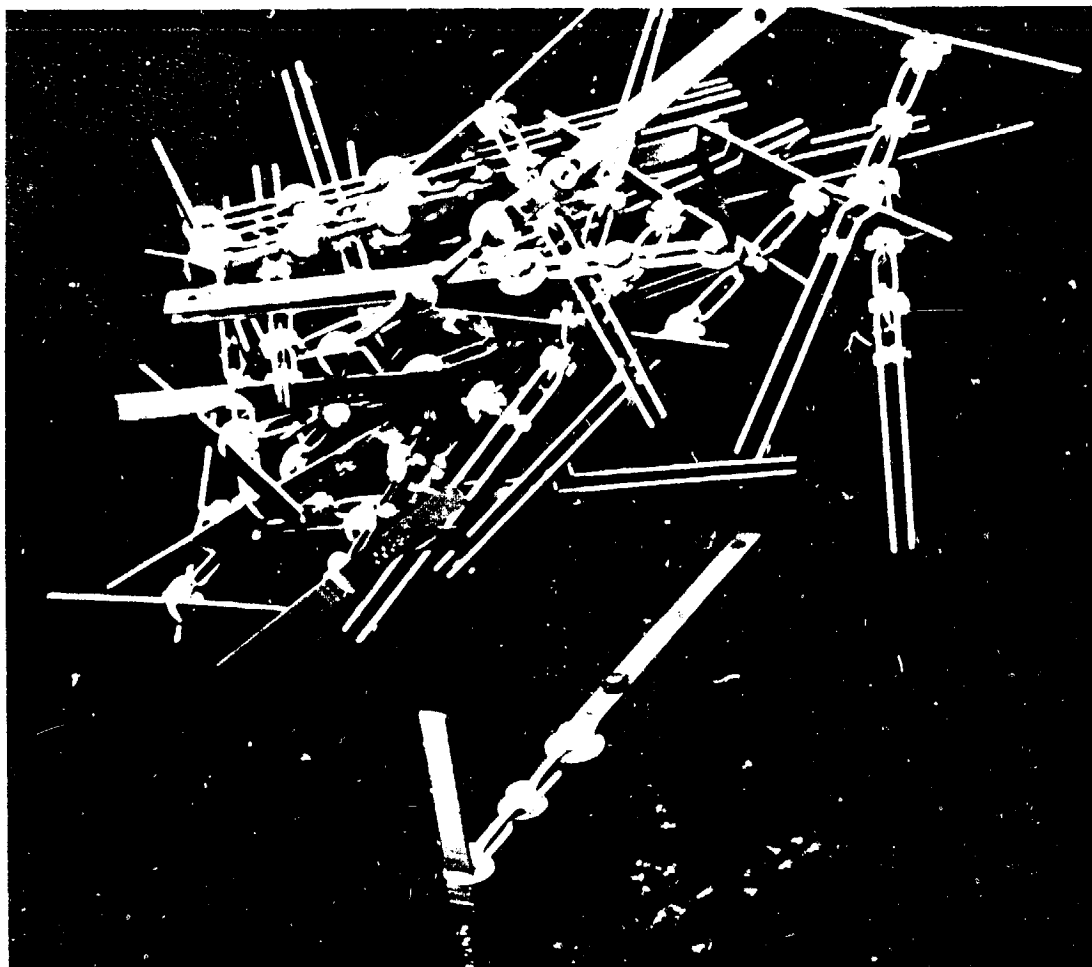

Fig. 2. Rectenna elements

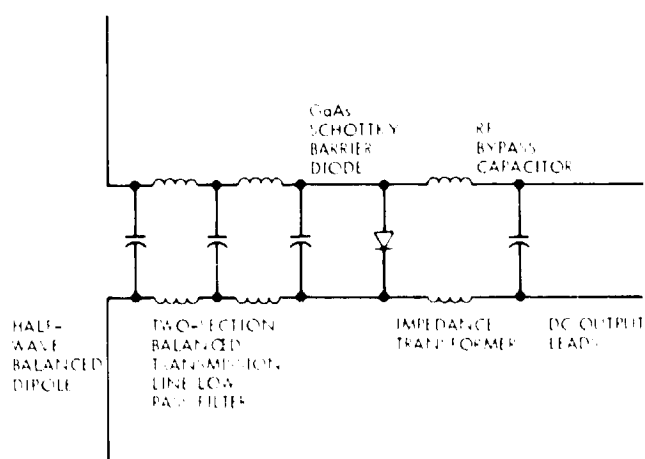

Fig. 3. Rectenna element equivalent circuit

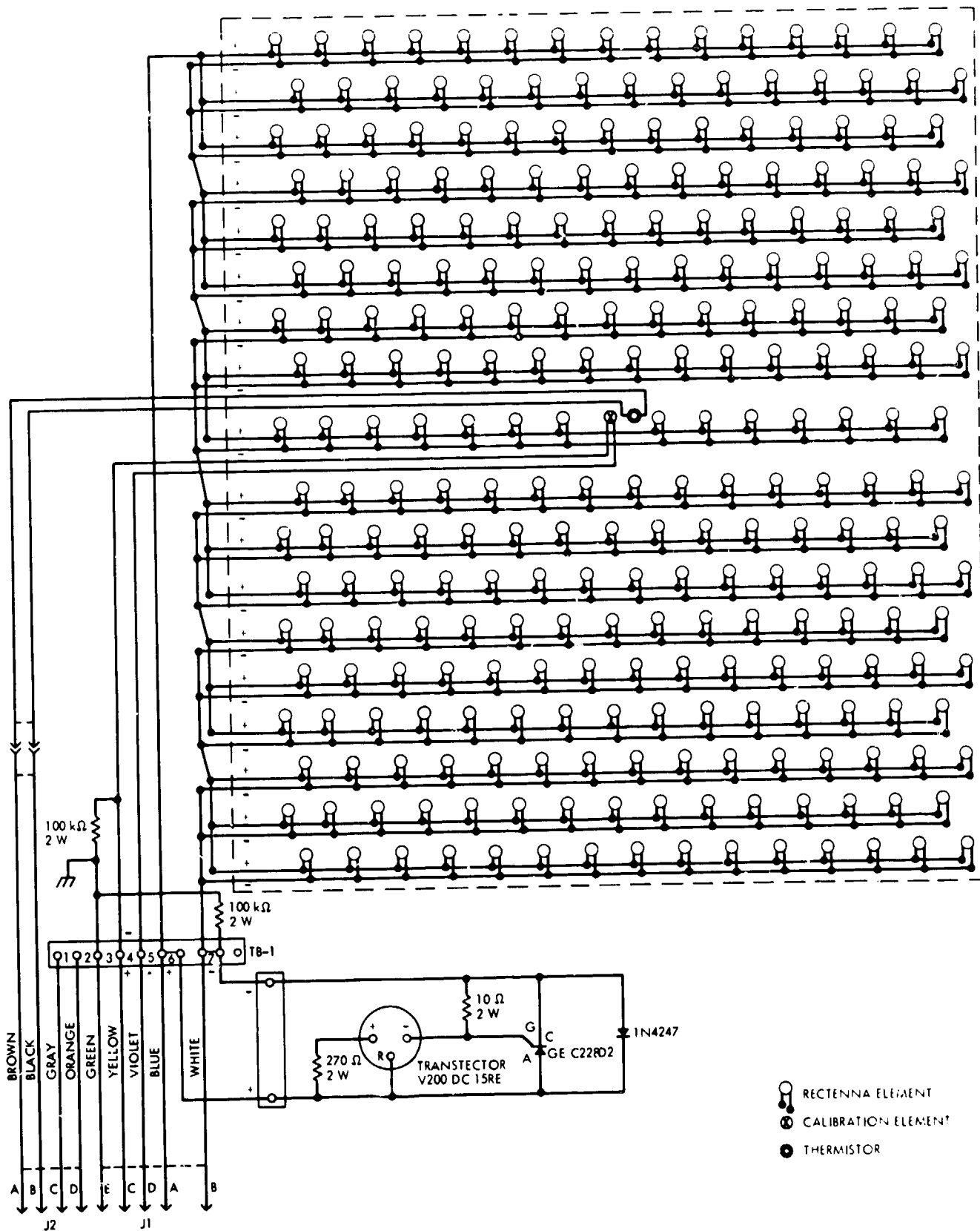

Fig. 4. Subarray wiring diagram

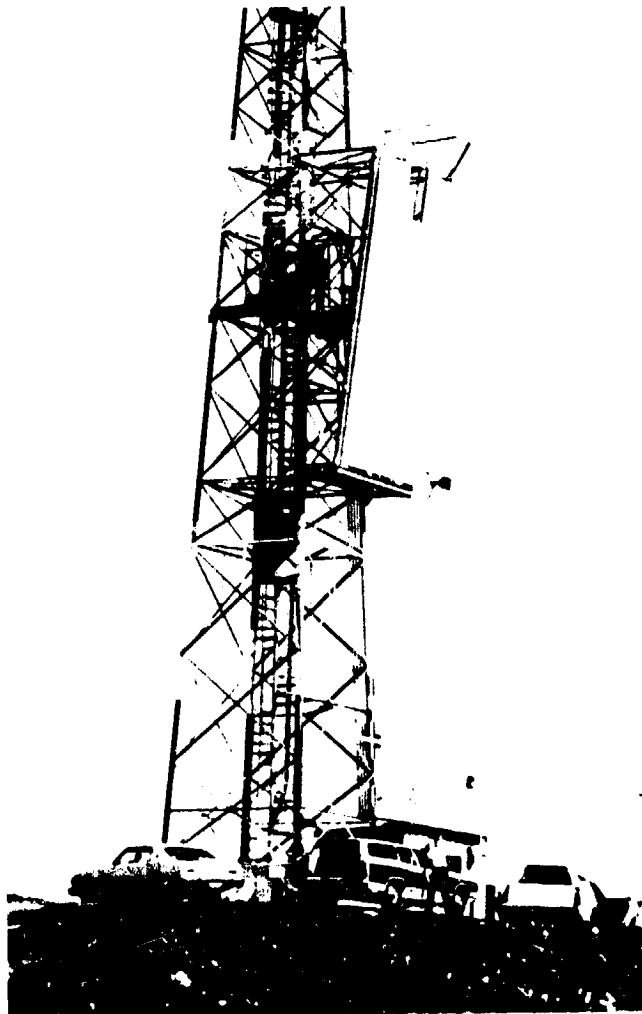

Fig. 5. The microwave power reception-conversion array (RXCv)

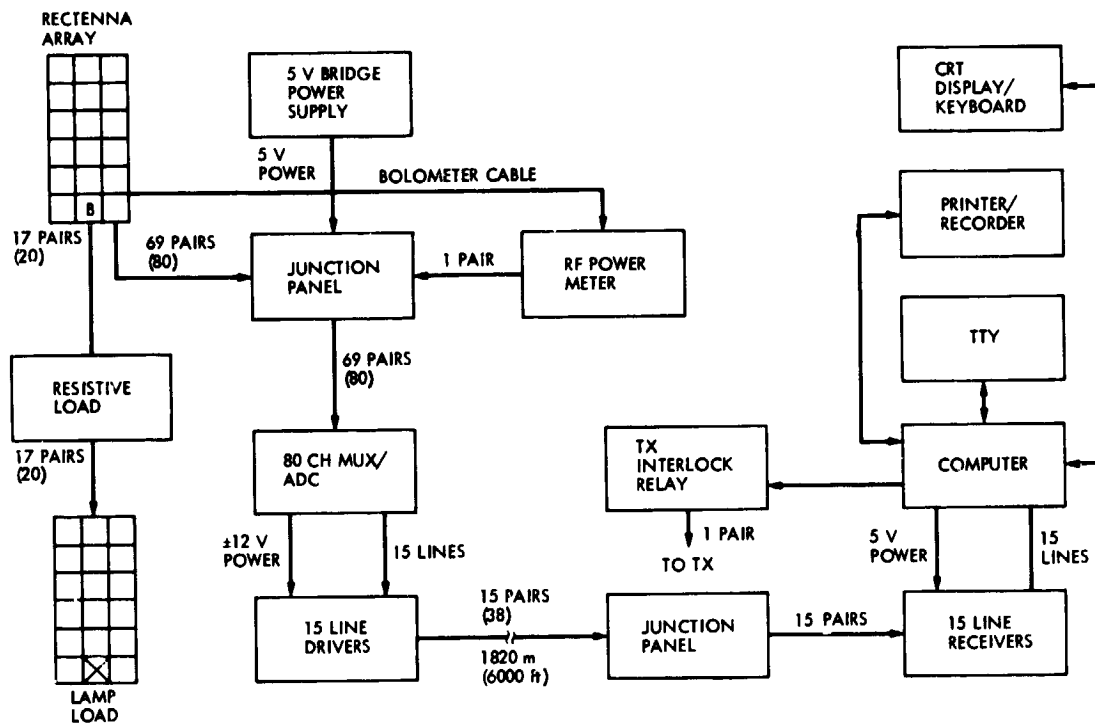

Fig. 6. Instrumentation and load system block diagram

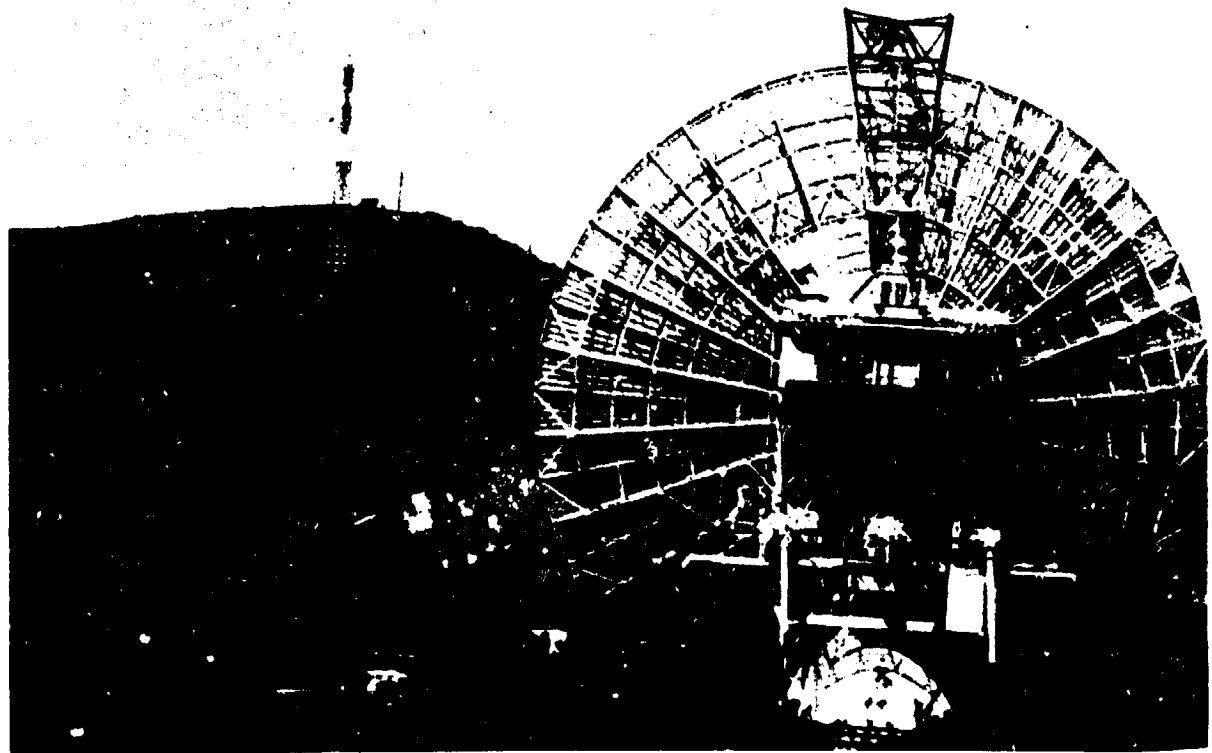

Fig. 7. Lamp load in operation

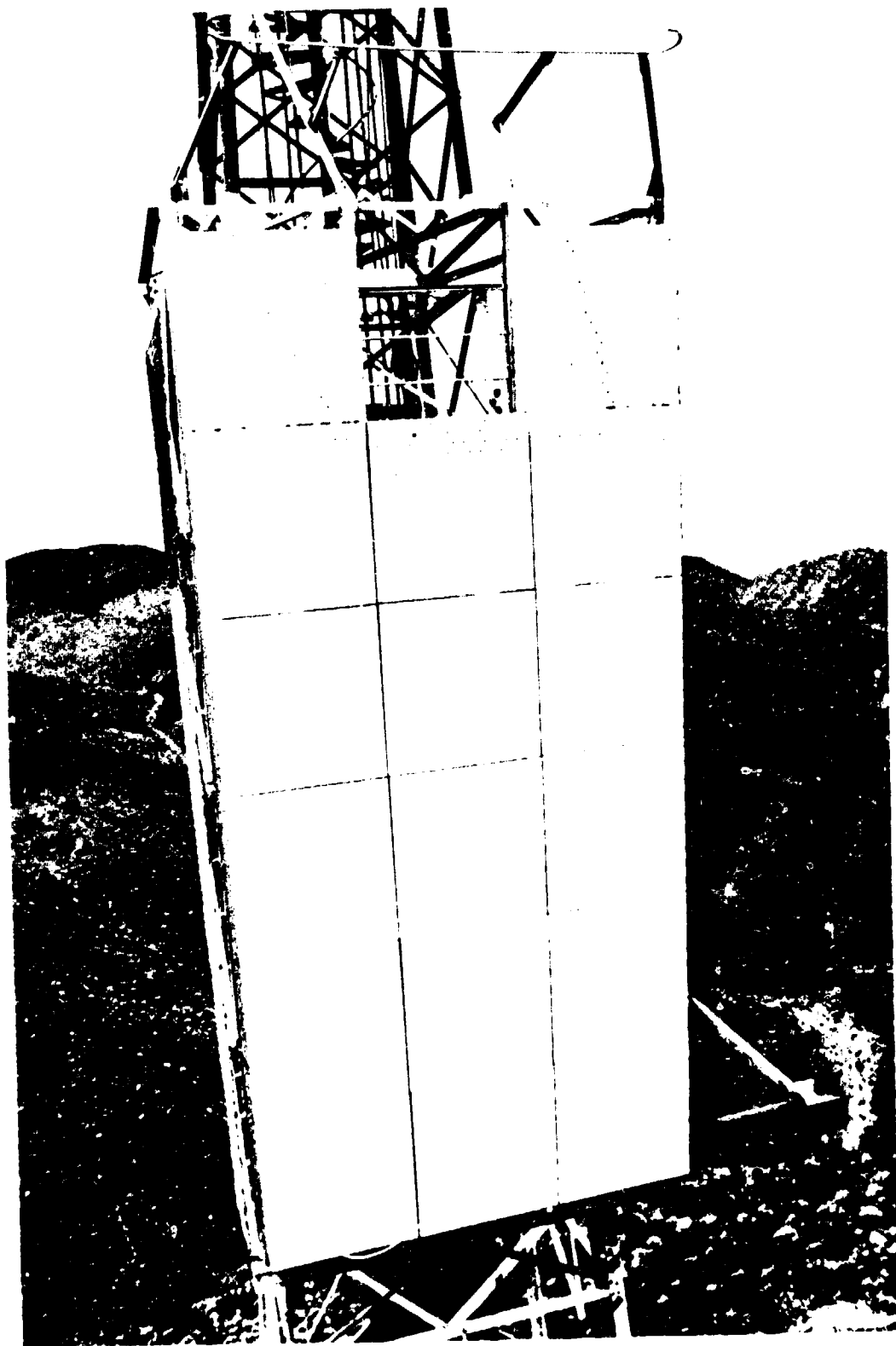

Fig. 8. RXCV array and field strength calibration horn



Fig. 9. RXCV data receiving and recording equipment

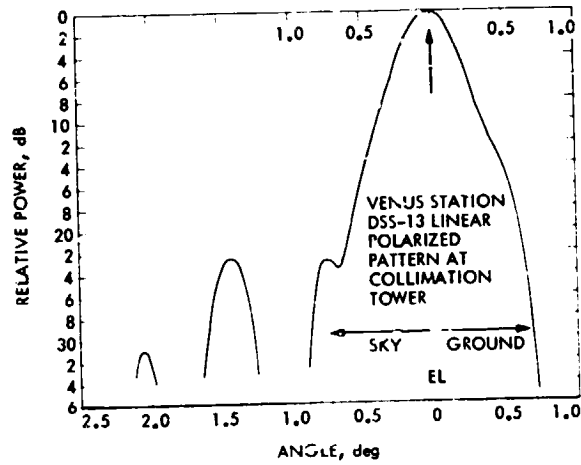

Fig. 10. 26-m antenna near field elevation pattern

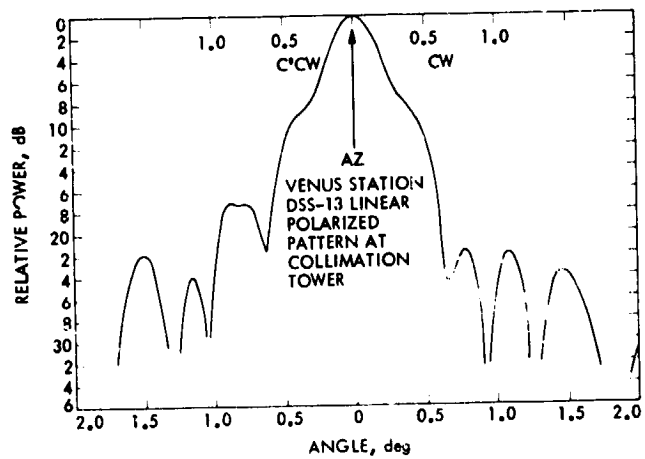

Fig. 11. 26-m antenna near field azimuth pattern

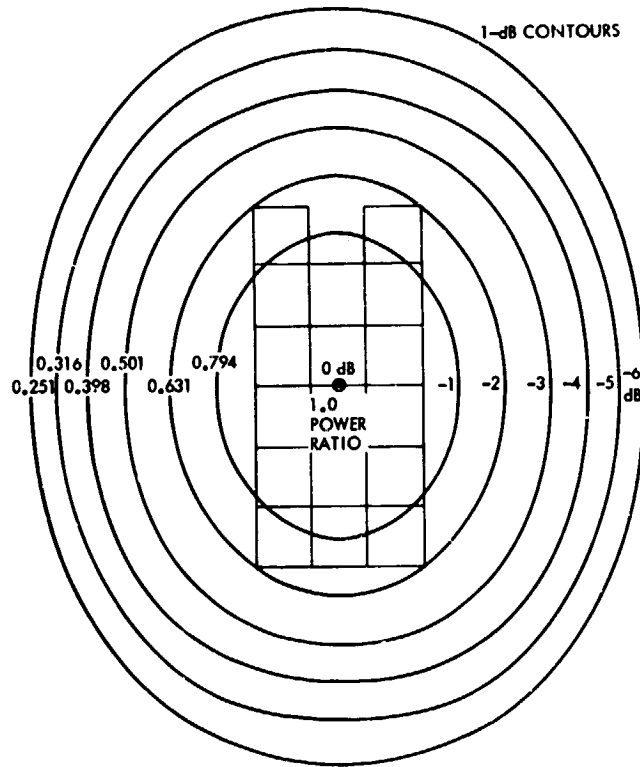

Fig. 12. 1-dB incident beam contours

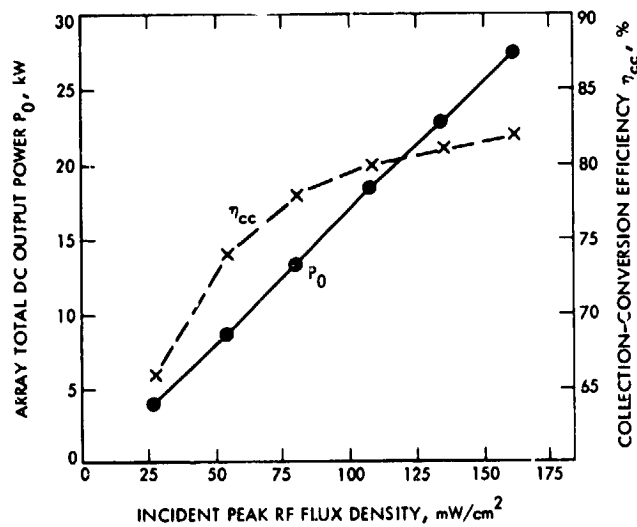

Fig. 13. Microwave high-power reception-conversion array performance

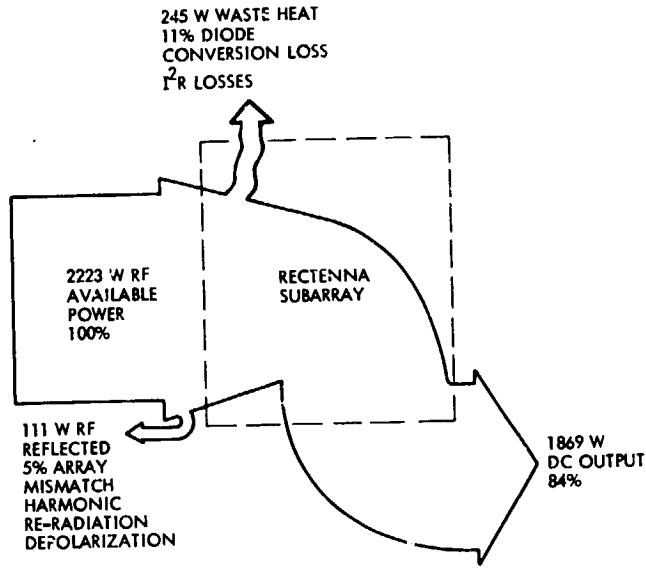

Fig. 14. Subarray power balance diagram for 162 mW/cm^2 peak RF incident flux density

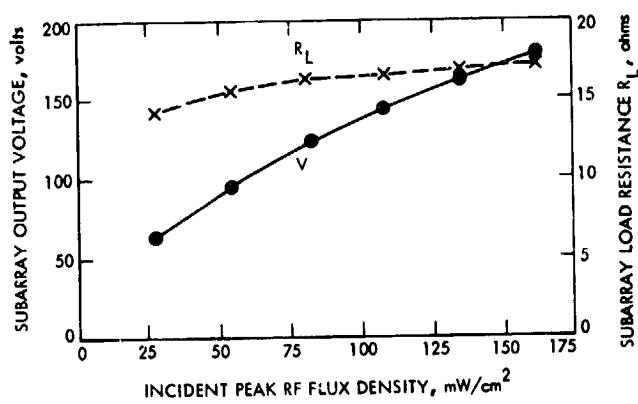

Fig. 15. Subarray output voltage and load characteristics

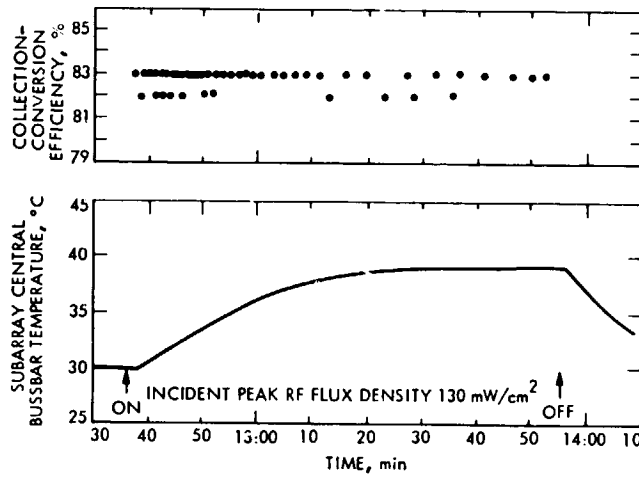

Fig. 16. Subarray performance variation versus temperature

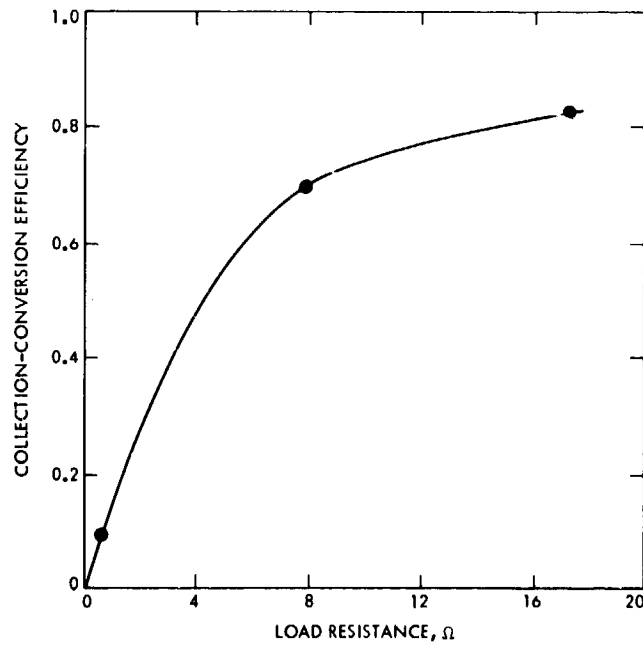

Fig. 17. Collection conversion efficiency versus load resistance for 130 mW/cm² peak incident RF power

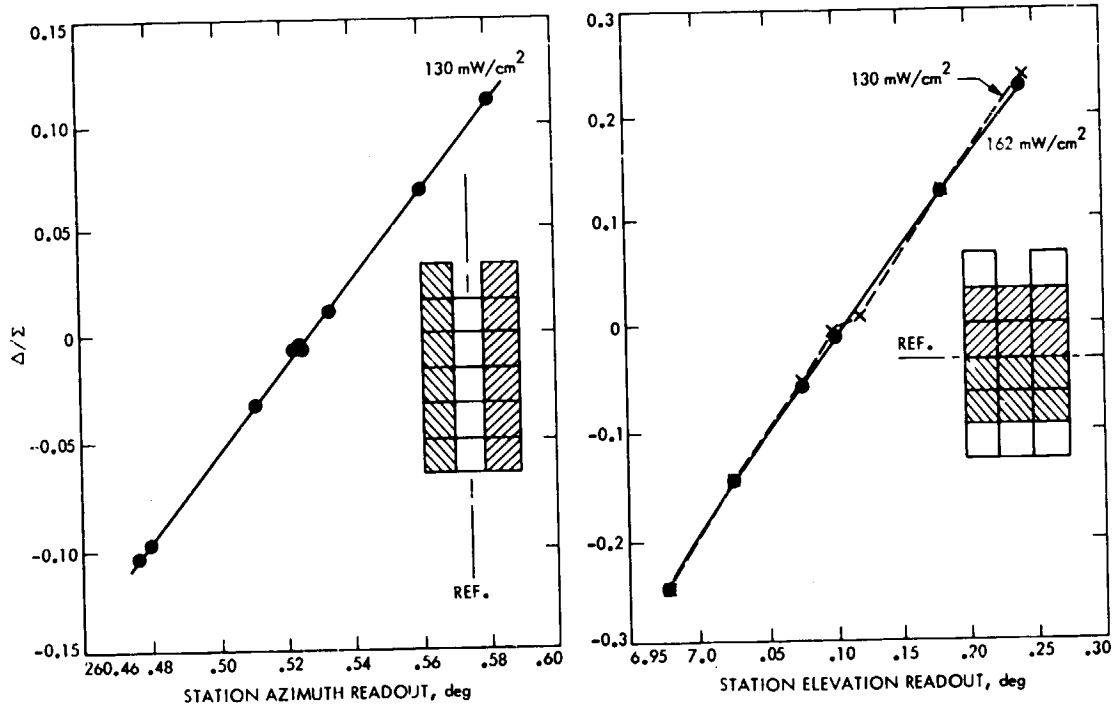

Fig. 18. Monopulse pointing performance, microwave power transmission reception array

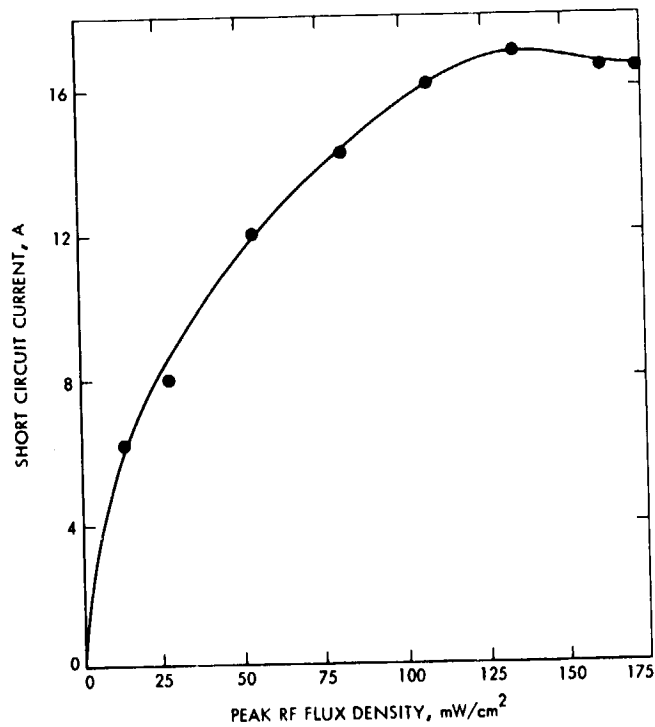

Fig. 19. Short circuit load performance of a subarray